

CHICAGO WELDING®

90 AMP FLUX WIRE WELDER

Model 98871

SET UP AND OPERATING INSTRUCTIONS



Visit our website at: <http://www.harborfreight.com>



**Read this material before using this product.
Failure to do so can result in serious injury.
SAVE THIS MANUAL.**

Copyright© 2008 by Harbor Freight Tools®. All rights reserved. No portion of this manual or any artwork contained herein may be reproduced in any shape or form without the express written consent of Harbor Freight Tools. Diagrams within this manual may not be drawn proportionally. Due to continuing improvements, actual product may differ slightly from the product described herein. Tools required for assembly and service may not be included.

For technical questions or replacement parts, please call 1-800-444-3353.

Manual Revised 10d

SAFETY

SETUP

BASIC WELDING

WELDING TIPS

SERVICE

SAVE THIS MANUAL

Keep this manual for the safety warnings and precautions, assembly, operating, inspection, maintenance and cleaning procedures. Write the product's serial number in the back of the manual near the assembly diagram (or month and year of purchase if product has no number). Keep this manual and the receipt in a safe and dry place for future reference.

IMPORTANT SAFETY INFORMATION

In this manual, on the labeling, and all other information provided with this product:



This is the safety alert symbol. It is used to alert you to potential personal injury hazards. Obey all safety messages that follow this symbol to avoid possible injury or death.

⚠ DANGER

DANGER indicates a hazardous situation which, if not avoided, will result in death or serious injury.

⚠ WARNING

WARNING indicates a hazardous situation which, if not avoided, could result in death or serious injury.

⚠ CAUTION

CAUTION, used with the safety alert symbol, indicates a hazardous situation which, if not avoided, could result in minor or moderate injury.

NOTICE

NOTICE is used to address practices not related to personal injury.

CAUTION

CAUTION, without the safety alert symbol, is used to address practices not related to personal injury.

General Safety Warnings



WARNING Read all safety warnings and instructions. *Failure to follow the warnings and instructions may result in electric shock, fire and/or serious injury.*

Save all warnings and instructions for future reference.

1. **Work area safety**
 - a. **Keep work area clean and well lit.** *Cluttered or dark areas invite accidents.*
 - b. **Do not operate welders in explosive atmospheres, such as in the presence of flammable liquids, gases or dust.** *Welders create sparks which may ignite the dust or fumes.*
 - c. **Keep children and bystanders away while operating a welder.** *Distractions can cause you to lose control.*
2. **Electrical safety**
 - a. **Welder plugs must match the outlet. Never modify the plug in any way. Do not use any adapter plugs with grounded welders.** *Unmodified plugs and matching outlets will reduce risk of electric shock.*
 - b. **Avoid body contact with grounded surfaces such as pipes, radiators, ranges and refrigerators.** *There is an increased risk of electric shock if your body is grounded.*
 - c. **Do not expose welders to rain or wet conditions.** *Water entering a welder will increase the risk of electric shock.*

- d. **Do not abuse the cord. Never use the cord for carrying, pulling or unplugging the welder. Keep cord away from heat, oil, sharp edges or moving parts. Damaged or entangled cords increase the risk of electric shock.**
 - e. **When operating a welder outdoors, use an extension cord suitable for outdoor use. Use of a cord suitable for outdoor use reduces the risk of electric shock.**
 - f. **If operating a welder in a damp location is unavoidable, use a Ground Fault Circuit Interrupter (GFCI) protected supply. Use of a GFCI reduces the risk of electric shock.**
3. **Personal safety**
- a. **Stay alert, watch what you are doing and use common sense when operating a welder. Do not use a welder while you are tired or under the influence of drugs, alcohol or medication. A moment of inattention while operating welders may result in serious personal injury.**
 - b. **Use safety equipment.** Always wear ANSI-approved safety glasses and arc shaded, impact safety full face shield. Safety equipment such as NIOSH-approved respirator, heavy-duty work gloves, non-skid safety shoes, or hearing protection used for appropriate conditions will reduce personal injuries.
 - c. **Prevent unintentional starting. Ensure the switch is in the off-position before connecting to power source or moving the welder. Carrying or energizing welders that have the switch on invites accidents.**
 - d. **Do not overreach. Keep proper footing and balance at all times. This enables better control of the welder in unexpected situations.**
4. **Welder use and care**
- a. **Do not use the welder if the switch does not turn it on and off. Any welder that cannot be controlled with the switch is dangerous and must be repaired.**
 - b. **Disconnect the plug from the power source before making any adjustments, changing accessories, or storing welders. Such preventive safety measures reduce the risk of starting the welder accidentally.**
 - c. **Store idle welders out of the reach of children and do not allow persons unfamiliar with the welder or these instructions to operate the welder. Welders are dangerous in the hands of untrained users.**
 - d. **Maintain welders. Check for misalignment or binding of moving parts, breakage of parts and any other condition that may affect the welder's operation. If damaged, have the welder repaired before use. Many accidents are caused by poorly maintained welders.**
 - e. **Use the welder and accessories in accordance with these instructions, taking into account the working conditions and the work to be performed. Use of the welder for operations different from those intended could result in a hazardous situation.**
- e. **Only use safety equipment that has been approved by an appropriate standards agency. Unapproved safety equipment may not provide adequate protection. Eye protection must be ANSI-approved and breathing protection must be NIOSH-approved for the specific hazards in the work area.**

5. Service

- a. **Have your welder serviced by a qualified repair person using only identical replacement parts.** *This will ensure that the safety of the welder is maintained.*

Welder Safety Warnings

1. **Maintain labels and nameplates on the Welder.** These carry important information. If unreadable or missing, contact Harbor Freight Tools for a replacement.
2. **Maintain a safe working environment.** Keep the work area well lit. Make sure there is adequate surrounding workspace. Always keep the work area free of obstructions, grease, oil, trash, and other debris.
3. **Avoid unintentional starting.** Make sure you are prepared to begin work before turning on the Welder.
4. **Unplug before performing maintenance.** Unplug the Welder from its electrical outlet before performing any inspection, maintenance, or cleaning procedures.
5. **Never leave the Welder unattended while energized.** Turn power off if you have to leave the Welder.



Prevent eye injury and burns. Wearing and using ANSI-approved personal safety clothing and safety devices reduce the risk for injury.

- Wear ANSI-approved safety impact eye goggles underneath welding eye protection featuring at least a number 10 shade lens rating, such as the one included.

- Leather leggings, fire resistant shoes or boots should be worn when using this product. Do not wear pants with cuffs, shirts with open pockets, or any clothing that can catch and hold molten metal or sparks.
- Keep clothing free of grease, oil, solvents, or any flammable substances. Wear dry, insulating gloves and protective clothing.
- Wear an approved head covering to protect the head and neck. Use aprons, cape, sleeves, shoulder covers, and bibs designed and approved for welding and cutting procedures.
- When welding/cutting overhead or in confined spaces, wear flame resistant ear plugs or ear muffs to keep sparks out of ears.

7.



Prevent accidental fires.

Remove any combustible material from the work area.



- When possible, move the work to a location well away from combustible materials. If relocation is not possible, protect the combustibles with a cover made of fire resistant material.
- Remove or make safe all combustible materials for a radius of 35 feet (10 meters) around the work area. Use a fire resistant material to cover or block all open doorways, windows, cracks, and other openings.
- Enclose the work area with portable fire resistant screens. Protect combustible walls, ceilings, floors, etc., from sparks and heat with fire resistant covers.
- If working on a metal wall, ceiling, etc., prevent ignition of combustibles on the other side by moving the combustibles to a safe location. If relocation of combustibles is not possible, designate someone to serve as a fire watch,

equipped with a fire extinguisher, during the cutting process and for at least one half hour after the cutting is completed.

- Do not weld or cut on materials having a combustible coating or combustible internal structure, as in walls or ceilings, without an approved method for eliminating the hazard.
- Do not dispose of hot slag in containers holding combustible materials. Keep a fire extinguisher nearby and know how to use it.
- After spot welding, make a thorough examination for evidence of fire. Be aware that easily visible smoke or flame may not be present for some time after the fire has started. Do not weld or cut in atmospheres containing dangerously reactive or flammable gases, vapors, liquids, and dust. Provide adequate ventilation in work areas to prevent accumulation of flammable gases, vapors, and dust. Do not apply heat to a container that has held an unknown substance or a combustible material whose contents, when heated, can produce flammable or explosive vapors. Clean and purge containers before applying heat. Vent closed containers, including castings, before preheating, welding, or cutting.

8. **Avoid overexposure to fumes and gases.** Always keep your head out of the fumes. Do not breathe the fumes. Use enough ventilation or exhaust, or both, to keep fumes and gases from your breathing zone and general area.
- Where ventilation is questionable, have a qualified technician take an air sampling to determine the need for corrective measures. Use mechanical ventilation to improve air quality. If engineering controls are not feasible, use an approved respirator.

- Work in a confined area only if it is well-ventilated, or while wearing an air-supplied respirator.
- Follow OSHA guidelines for Permissible Exposure Limits (PEL's) for various fumes and gases.
- Follow the American Conference of Governmental Industrial Hygienists recommendations for Threshold Limit Values (TLV's) for fumes and gases.
- Have a recognized specialist in Industrial Hygiene or Environmental Services check the operation and air quality and make recommendations for the specific welding or cutting situation.

⚠ WARNING	
	
INHALATION HAZARD: Welding and Plasma Cutting Produce TOXIC FUMES.	
<p>Exposure to welding or cutting exhaust fumes can increase the risk of developing certain cancers, such as cancer of the larynx and lung cancer. Also, some diseases that may be linked to exposure to welding or plasma cutting exhaust fumes are:</p> <ul style="list-style-type: none">• Early onset of Parkinson's Disease• Heart disease• Damage to the reproductive organs• Inflammation of the small intestine or stomach• Respiratory diseases such as emphysema, bronchitis, or pneumonia• Ulcers• Kidney damage	
<p>Use natural or forced air ventilation and wear a respirator approved by NIOSH to protect against the fumes produced to reduce the risk of developing the above illnesses.</p>	

9. **Do not touch live electrical parts.** Wear dry, insulating gloves. Do not touch welding wire or gun with bare hand. Do not wear wet or damaged gloves.
10. **Protect yourself from electric shock.** Do not use outdoors. Insulate yourself from the workpiece and ground. Use nonflammable, dry insulating material if possible, or use dry rubber mats, dry wood or plywood, or other dry insulating material big enough to cover your full area of contact with the work or ground.
11. **People with pacemakers should consult their physician(s) before using this product.** Electromagnetic fields in close proximity to a heart pacemaker could cause interference to, or failure of the pacemaker.
12. **Use care not to touch the welding tip to grounded material whenever the unit is plugged in. This unit is what is referred to as a “hot tip” welder, meaning that current is available to the wire at all times that the power Switch (7a) is in the ON position.** Electric shock, fire, or burns may happen if appropriate precautions are not taken.
13. **Ensure that the unit is placed on a stable location before use.** If this unit falls while plugged in, severe injury, electric shock, or fire may result.
14. This product, when used for welding and similar applications, contains or produces a chemical known to the State of California to cause cancer and birth defects (or other reproductive harm). (California Health & Safety Code § 25249.5, *et seq.*)
15. Handling the cord on this product will expose you to lead, a chemical known to the State of California to cause cancer, and birth defects or other reproductive harm. Wash hands after handling. (California Health & Safety Code § 25249.5, *et seq.*)
16. The warnings, precautions, and instructions discussed in this instruction manual cannot cover all possible conditions and situations that may occur. It must be understood by the operator that common sense and caution are factors which cannot be built into this product, but must be supplied by the operator.



SAVE THESE INSTRUCTIONS.

GROUNDING

⚠️ WARNING

TO PREVENT ELECTRIC SHOCK

AND DEATH FROM INCORRECT GROUNDING WIRE CONNECTION:



Check with a qualified electrician if you are in doubt as to whether the outlet is properly grounded. Have a plug installed by a certified electrician. Do not use the welder if the power cord or plug is damaged. If damaged, have it repaired by a service facility before use. If the plug will not fit the outlet, have a proper outlet installed by a qualified electrician.







Grounded Welders

1. The grounding prong in the plug is connected through the green wire inside the cord to the grounding system in the welder. The green wire in the cord must be the only wire connected to the welder's grounding system and must never be attached to an electrically "live" terminal.
2. The welder must be plugged into an appropriate outlet, properly installed and grounded in accordance with all codes and ordinances.
6. If you are using an extension cord outdoors, make sure it is marked with the suffix "W-A" ("W" in Canada) to indicate it is acceptable for outdoor use.
7. Make sure the extension cord is properly wired and in good electrical condition. Always replace a damaged extension cord or have it repaired by a qualified electrician before using it.
8. Protect the extension cords from sharp objects, excessive heat, and damp or wet areas.

Extension Cords

1. **If an extension cord is used, it must have the following wire size: up to 30 feet, use 10 AWG size wire; 30 to 50 feet, use 8 AWG wire; Over 50 feet, use 6 AWG wire.**
2. As the distance from the supply outlet increases, you must use a heavier gauge extension cord. Using extension cords with inadequately sized wire causes a serious drop in voltage, resulting in loss of power and possible welder damage.
3. The smaller the gauge number of the wire, the greater the capacity of the cord. For example, a 14 gauge cord can carry a higher current than a 16 gauge cord.
4. When using more than one extension cord to make up the total length, make sure each cord contains at least the minimum wire size required.
5. If you are using one extension cord for more than one welder, add the nameplate amperes and use the sum to determine the required minimum cord size.

SYMBOLOLOGY

	Wire Feed (Speed)
	Workpiece Ground Cable
	Gun Cable
	Overheat Shutdown Indicator
	Cooling Fan
	Housing Ground Point
V~	Volts Alternating Current
A	Amperes
OCV	Open Circuit Voltage
KVA	Kilovolt Amperes (Volts / 1000 * Amperes)
IPM	Inches Per Minute
AWG	American Wire Gauge

SPECIFICATIONS

Power Input	120 V~, 24 A (peak), 1-phase Connect to at least 20 A dedicated circuit
Welding Output	DCEN MIN: 63 ~ 68 A MAX: 79 ~ 90 A HOT TIP welder
Capacity	22 gauge (0.03") to 3/16" (0.19") mild steel only Not for welding aluminum or stainless steel
Duty Cycle	25% at MAX setting 45% at MIN setting (See explanation on page 16)
Open Circuit Voltage	31
KVA	3.6
Wire Speed	101 – 342 IPM
Cable Sizes	Ground: 6 AWG, 6' Gun: 8 AWG, 6' Power: 3-wire, 14 AWG
Welder Tips / Wire Size	Installed tip will accept .030" to .035" FLUX CORE wire
Wire Spool Capacity	4" diameter / 2 lb. spool
Internal Fuse	2 A 250 V Tube fuse (see page 27)
Accessories	Spare Welder Tip (for .030" to .035" wire) Welding Face Shield Combination Wire Brush / Chipping Hammer

UNPACKING

When unpacking, make sure that the item is intact and undamaged. If any parts are missing or broken, please call Harbor Freight Tools at 1-800-444-3353 as soon as possible.

SETUP



Read the **ENTIRE IMPORTANT SAFETY INFORMATION** section at the beginning of this manual including all text under subheadings therein before set up or use of this product.

WARNING

TO PREVENT SERIOUS INJURY FROM ACCIDENTAL OPERATION:
Turn the Power Switch off and unplug the welder before assembly.

Face Shield (38) Assembly

Attach the handle to the Face Shield (38) by lining up the two rectangular tabs on the handle with the corresponding holes in the face shield and

- A. press the tabs through the holes and then
- B. slide the tabs forward from the back, locking the round tab in place.

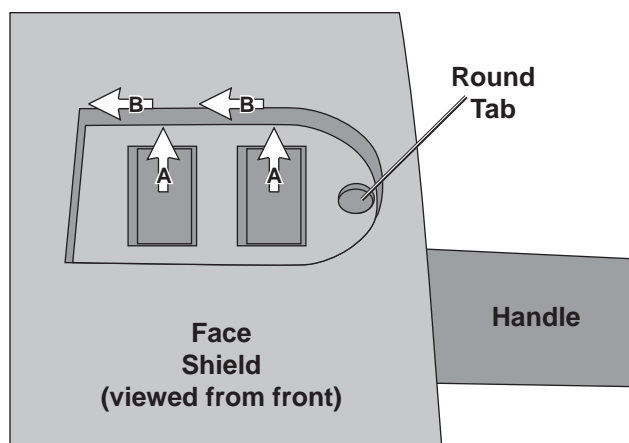

Cover (31) Assembly

1. Slide the Handle (30) into the slot on the Cover (31) from the front. The notch on the back of the Handle should drop into the slot in the Cover. Both ends of the Handle should lay flush against the top of the Cover. Then, secure using Screw (29) as shown.

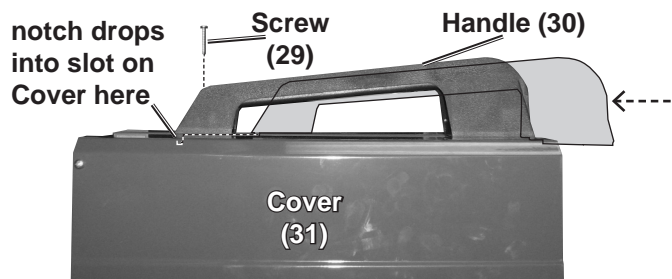

2. Attach the Cover Latch (8) to the front of the Base Frame (14) using the Bolt (42), Washer (40), Lock Washer (50) and Nut (41) as shown.

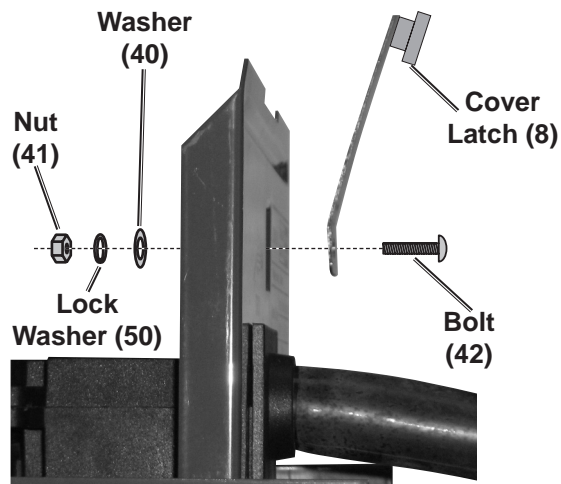

Wire Spool (27) Installation

1. Turn the welder OFF and unplug it before proceeding.

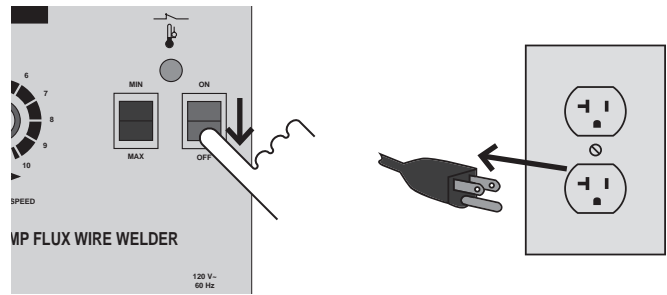

2. Press in the Cover Latch (8) on the front of the handle, then open the Cover (31).



3. Remove the Wing Nut (25) and the Spool Retaining Nut (26). If replacing a Spool, remove the old Spool and all remaining wire from the liners.

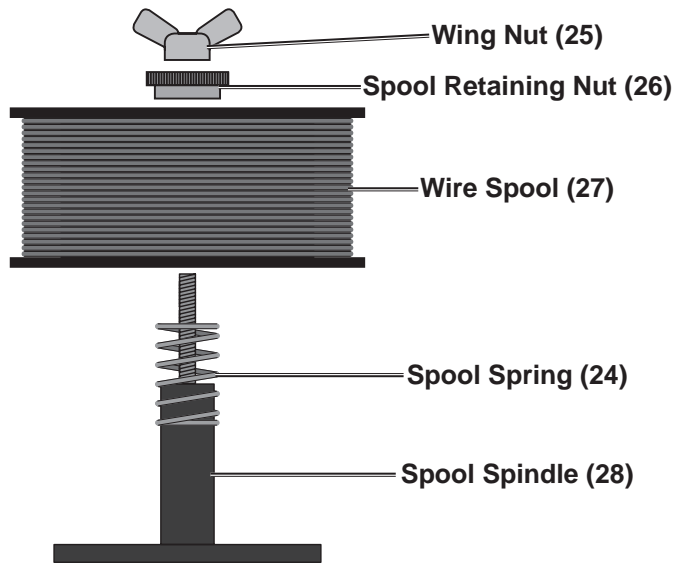

4. Make sure the Spool Spring (24) is in place on the Spool Spindle (28). Place the new **flux core** Wire Spool over the Spool Spindle (28) and on top of the Spool Spring (24) as illustrated. **To prevent wire feed problems, set the Spool so that it will unwind counterclockwise.**

5. Secure Spool in place with the Spool Retaining Nut (26), then the Wing Nut (25).

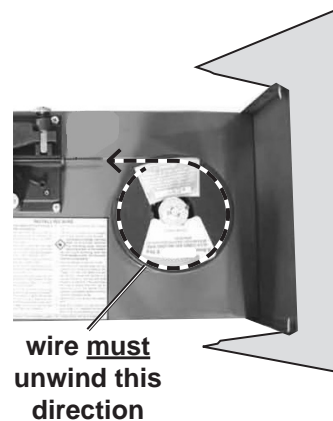

- Turn the Feed Tensioner (37) knob counterclockwise to loosen it enough to pull it up, releasing tension. Do not loosen the Tensioner knob too much, or the Tensioner will come apart. Then, swing the Feed Swing Arm (36) out.

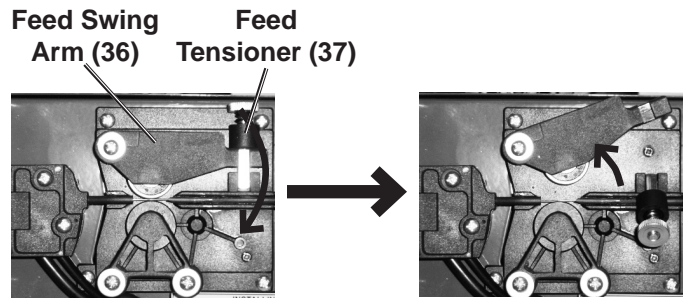

- Compare the wire diameter marked on the Wire Spool (27) with the stamped number on the top of the Feed Roller (34). The Roller's groove size must be compatible with the wire diameter - .8mm rollers also work with .030" wire & .9mm rollers also work with .035" wire. **If it is not compatible or the number on the Roller is hidden:**

- Remove the Screws (45) and Washers (46) from the Feed Roller Bracket (44).
- Remove the Feed Roller Bracket. Flip the Feed Roller (34) as needed and confirm that the number facing up is the same as the wire diameter on the Spool.
- Reassemble using the Feed Roller Bracket, Washers, and Screws.

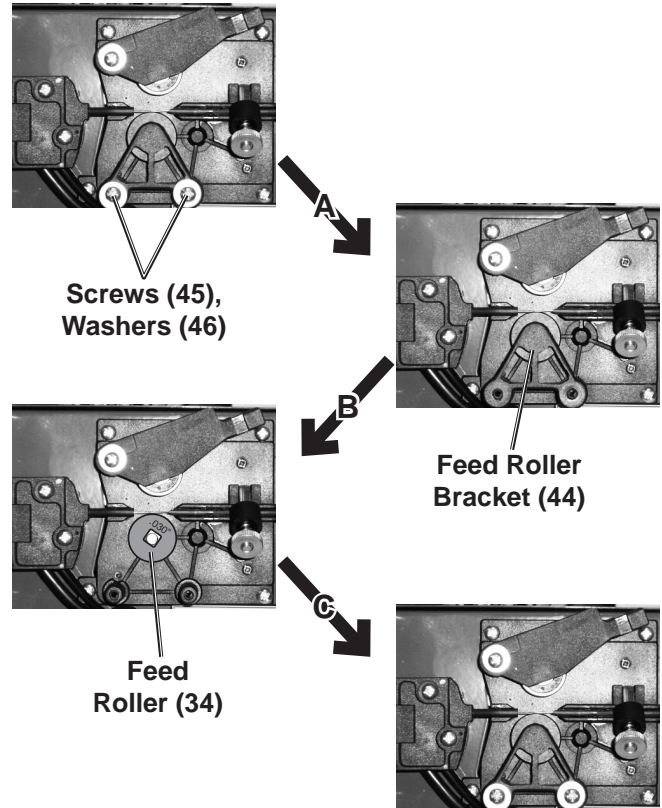

IMPORTANT:

Securely hold onto the end of the welding wire and keep tension on it during the following steps.

If this is not done, the welding wire will unravel and create a tangled "bird's nest", wasting wire.

- Cut off all bent and crimped wire. Make sure that the cut end has no burrs or sharp edges; cut again if needed.
- Keep tension on the wire and guide at least 12 inches of wire into the Wire Liners.

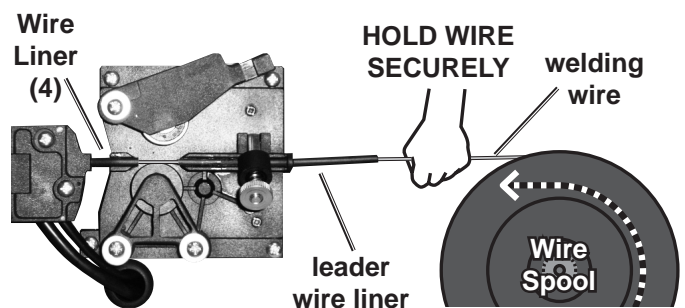

10. Swing the Wire Feed Swing Arm (36) closed, and swing the Feed Tensioner (37) across the tip of the Arm, to latch it. Make sure the Welding Wire is resting in the top groove of the Feed Roller (34), then turn the Feed Tensioner knob clockwise a couple of turns. After the wire is held by the Tensioner, you may release it.

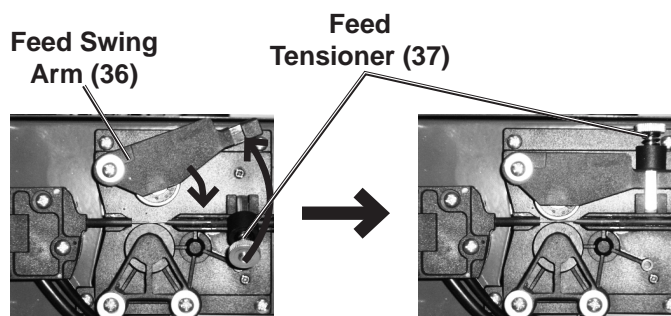

11. Pull the Nozzle (3) to remove it.
12. Using the third oval hole on the Multi-wrench (43), turn the Contact Tip (2b) counterclockwise and remove.
13. Lay the Gun Cable out in a straight line so that the wire moves through it easily. Leave the cover open, so that the feed mechanism can be observed.

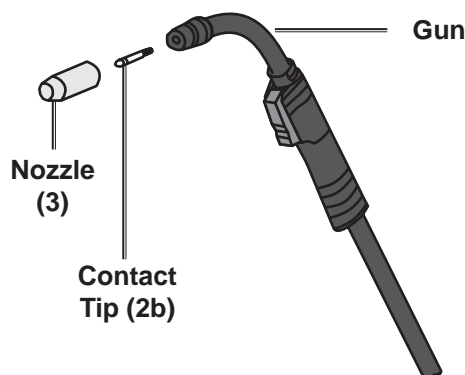

⚠ WARNING

The following steps require applying power to the welder with the cover open.

To prevent serious injury from fire or electric shock:

1. **Do not touch anything, especially not the Ground Clamp, with the Gun or welding wire or an arc will be ignited.**
2. **Do not touch internal welder components while it is plugged in.**

14. Do not touch the Gun's Trigger (1c). Plug the Power Cord into its electrical outlet and turn the welder ON.

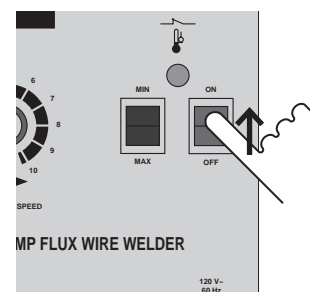
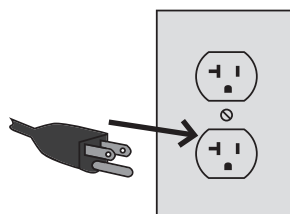

- Point the Gun away from all objects and press the Trigger (1c) until the wire feeds out of the gun two inches.

The Wire Liner (4) may come out with the welding wire, this is normal, just push the Wire Liner back into the Gun. If the wire does not feed properly and the Spool is stationary, turn the welder OFF, unplug it, and slightly tighten the Feed Tensioner (37) clockwise before retrying.

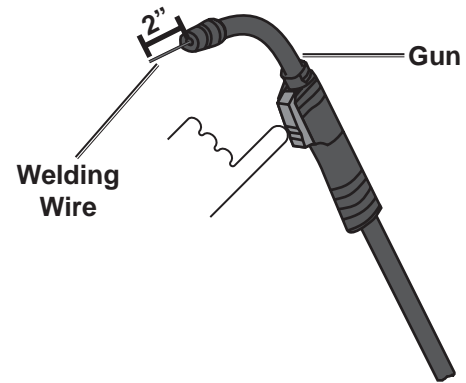

- To check the wire's drive tension, feed the wire against a piece of wood from 2 to 3 inches away. If the wire stops instead of bending, turn the welder OFF, unplug it, slightly tighten the Feed Tensioner (37) clockwise, and try again. If the wire bends from the feed tension, then the tension is set properly.

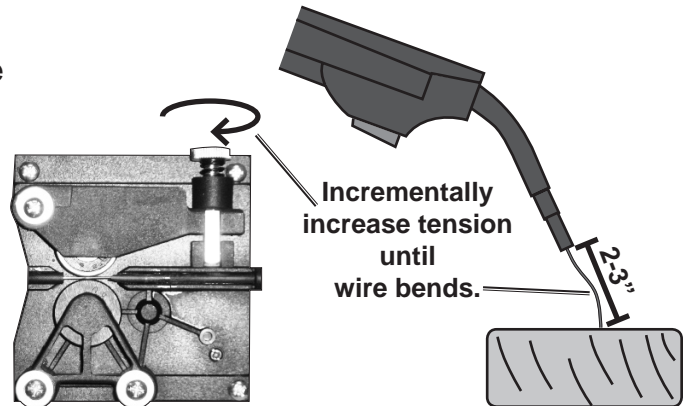

- TURN THE WELDER OFF.**

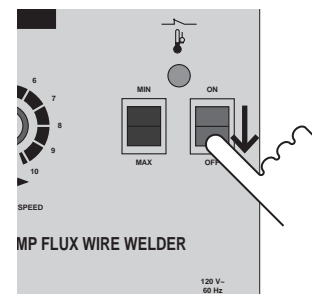

- Select a Contact Tip that is compatible with the welding wire used. The included Tip (2b, .035") will work with both .030" and .035" wire. Slide the Contact Tip over the wire and thread it clockwise into the Gun. Tighten the Contact Tip using the Multi-wrench (43).

- Replace the Nozzle (3) and cut the wire off at $\frac{1}{2}$ " from tip ($\frac{1}{2}$ " stickout).

- Swing the Cover (31) closed until the Cover Latch (8) locks in place.

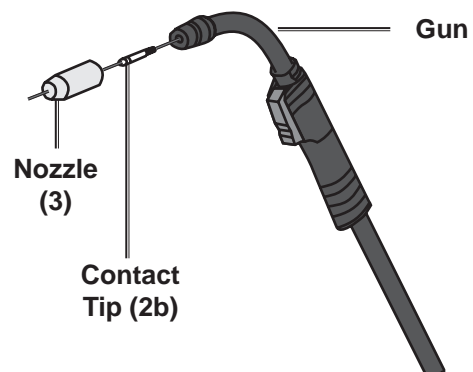

BASIC WELDING



Read the **ENTIRE IMPORTANT SAFETY INFORMATION** section at the beginning of this manual including all text under subheadings therein before welding.

⚠️ WARNING

TO PREVENT SERIOUS INJURY:

Protective gear must be worn when using the Welder; minimum shade number 10 full face shield (or welding mask), ear protection, welding gloves, sleeves and apron, NIOSH-approved respirator, and fire resistant work clothes without pockets should be worn when welding.

Light from the arc can cause permanent damage to the eyes and skin.

Do not breathe arc fumes.



⚠️ WARNING

TO PREVENT SERIOUS INJURY, FIRE AND



BURNS:

Keep welding tip clear of grounded objects whenever unit is plugged in.

This welder is a “hot tip” welder, meaning that current is available to the wire whenever the Power Switch is on.

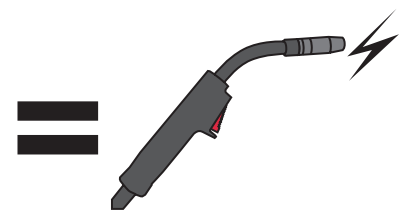
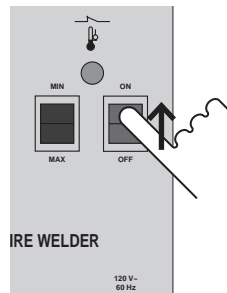

The Flux Wire Welder is used to weld sheet metal and low carbon steel. Good welding takes a degree of skill and experience. Practice a few sample welds on scrap before welding your first project. Additional practice periods are recommended whenever you weld a different thickness of material or weld a different type of connection. **Make practice welds on pieces of scrap to practice technique before welding anything of value.**

Practice your welding technique on scrap pieces before welding anything of value.

Control Panel Layout

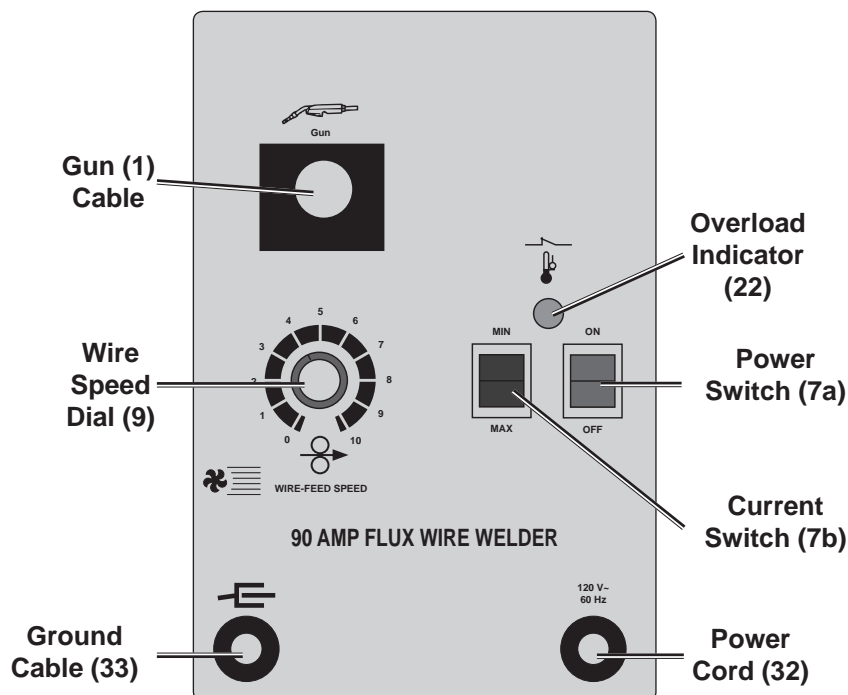

Gun Cable: The welding Gun connects here. The wire and welding current feeds to the weld through here. The welding Gun is energized whenever the Power Switch is on.

Wire Speed Dial: This controls the speed that the welding wire feeds out of the welding Gun. Adjust this according to the weld settings chart to achieve a good weld.

Ground Cable: This connects to the base metal to provide a good connection for the current to travel back to the welder.

Power Cord: Plug the Power Cord into a properly grounded 120 V~ outlet, on at least a 20 amp dedicated circuit with delayed action type circuit breaker or fuses.

Current Switch: This controls the output amperage of the welder. Adjust this according to the weld settings chart to achieve a good weld.

Power Switch: This turns on power to the welding Gun and internal cooling fan. The welding Gun is energized whenever the Power Switch is on.

Overload Indicator: This lights up if duty cycle work period is exceeded, overheating the welder. Rest the Gun on an electrically non-conductive, heat-resistant surface, such as a concrete slab, well clear of the ground clamp while allowing the welder to cool with the Power Switch on, so the Fan can help cool the welder. Once the welder cools enough to be used again, use shorter welding periods and longer rest periods to prevent needless wear.

Weld Settings Chart

NOTE: The numbers within the spaces are the approximate wire feed settings recommended* for this wire size and material thickness.	Material Thickness (Steel)					
	22 Gauge	18 Gauge	16 Gauge	14 Gauge	1/8"	3/16"
	MIN current				MAX current	
.030" Wire Size (Flux Core, Mild Steel)	1 speed	1.5 speed	2 speed	4 speed	8 speed	9 speed
.035" Wire Size (Flux Core, Mild Steel)	0.5 speed	1.5 speed	2 speed	3 speed	8 speed	9.5 speed

* This chart is only intended to show general guidelines for different wire sizes and for different thicknesses of material. The settings should only be used at the beginning of a weld and must be adjusted after stopping and carefully inspecting the weld. Proper welding takes experience.

Duty Cycle (Duration of Use)

Avoid damage to the Welder by not welding for more than the prescribed duty cycle time. The Duty Cycle defines the number of minutes, within a 10 minute period, during which a given welder can produce a particular welding current without overheating. For example, this Welder with a 25% duty cycle on MAX setting must be allowed to rest for at least 7 minutes, 30 seconds after every 2 minutes, 30 seconds of continuous weld. Failure to carefully observe duty cycle limitations can easily over-stress a welder's power generation system contributing to premature welder failure.

This welder has an internal thermal protection system to help prevent this sort of over-stress. When the unit overheats, it automatically shuts down and the Overload Indicator (22) lights, then the welder automatically returns to service after cooling off. Rest the Gun on an electrically non-conductive, heat-proof surface, such as a concrete slab, well clear of the ground clamp while allowing the welder to cool with the Power Switch on, so that the internal Fan will help cool the welder. When the welder can be used again, use shorter welding periods and longer rest periods to prevent needless wear.



25% Duty Cycle at MAX setting
2 minutes, 30 seconds welding
followed by
at least 7 minutes, 30 seconds of rest



45% Duty Cycle at MIN setting
4 minutes, 30 seconds welding
followed by
at least 5 minutes, 30 seconds of rest

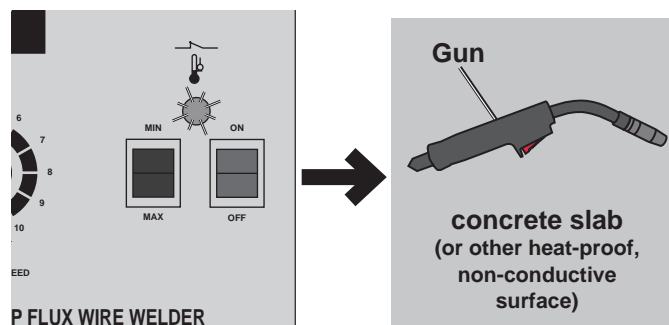

Setting Up The Weld

1. **Make practice welds on pieces of scrap the same thickness as your intended workpiece to practice technique before welding anything of value.** Clean the weld surfaces thoroughly with a wire brush or angle grinder; there must be no rust, paint, oil, or other materials on the weld surfaces, only bare metal.
2. Use clamps (not included) to hold the workpieces in position so that you can concentrate on proper welding technique. The distance (if any) between the two workpieces must be controlled properly to allow the weld to hold both sides securely while allowing the weld to penetrate fully into the joint. The edges of thicker workpieces may need to be chamfered (or beveled) to allow proper weld penetration.
3. Clamp Ground Cable to bare metal on the workpiece near the weld area, or to metal work bench where the workpiece is clamped.

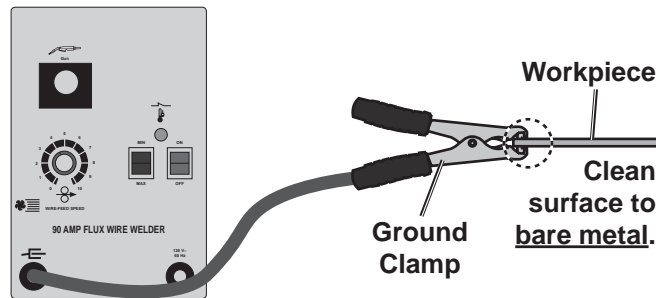
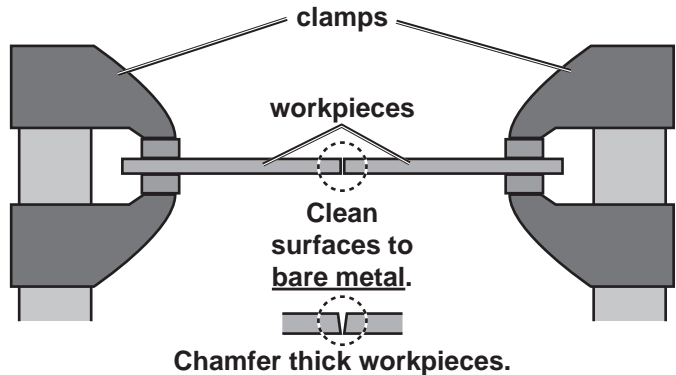

4. Set the Wire Speed Dial and the Current Switch to the desired settings. Refer to the chart on the welder or the chart on the facing page. **DO NOT SWITCH THE CURRENT WHILE WELDING.**

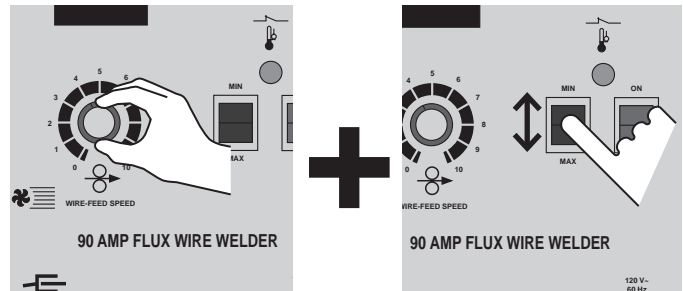

5. Flip the Power Switch to the OFF position, then plug the Welder into a dedicated, 120 V~, 20 A circuit with delayed action type circuit breaker or fuses.

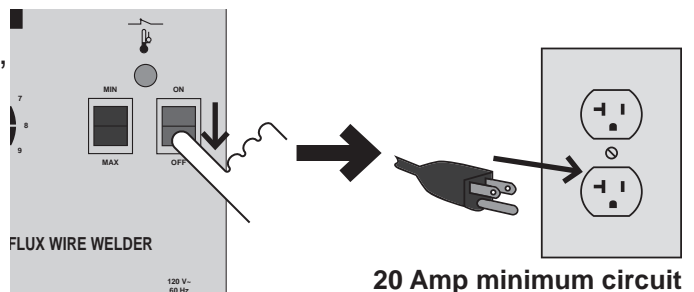

6. Hold the Gun, without touching the Trigger, with the wire and tip clearly out of the way of any grounded objects. Then, turn the Power Switch ON.

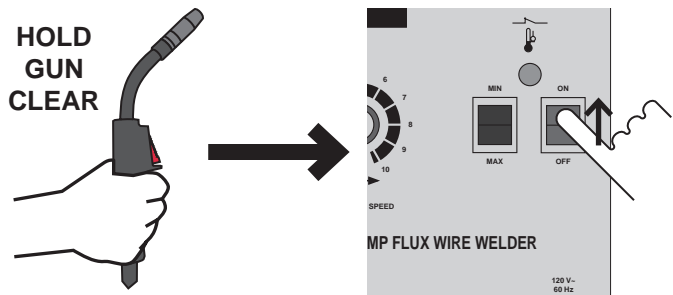

Basic Welding Technique

1. Press (and hold) Trigger and contact area to be welded with electrode wire to ignite arc.

2. For a narrow weld, you can usually draw the wire in a steady straight line, this is called a **stringer bead**.

stringer bead

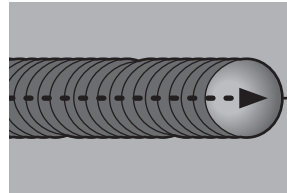

weave bead

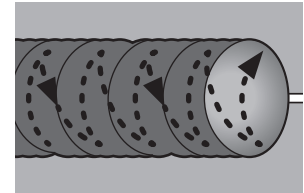

For a wider weld, draw the wire back and forth across the joint, this is called a **weave bead**.

3. Hold Gun in one hand and the face shield in the other. If a hands-free welding shield (not included, see #6, page 4 for guidelines) is used, then both hands can be used to control Gun.

4. Direct the welding wire straight into the joint. This gives an angle of 90° (straight up and down) for butt (end to end) welds, and an angle of 45° for fillet (T-shaped) welds.

Weld Gun angles, viewed from front of weld joint.

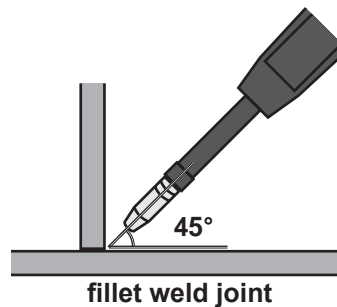

fillet weld joint

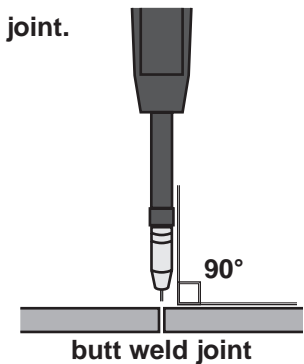

butt weld joint

5. The end of gun should be tilted so that wire is angled anywhere in-between straight on and 15° in the direction you are welding. The amount of tilt is called the **drag angle**.
6. The welding wire should extend no more than 1/2" past the tip. This distance is called **stickout** or **CTWD** - Contact Tip to Work Distance.

Drag Angle

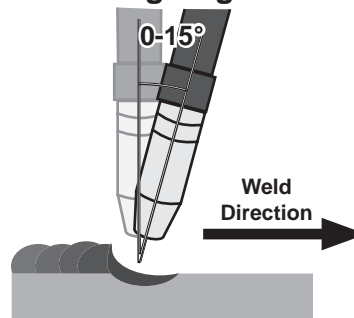
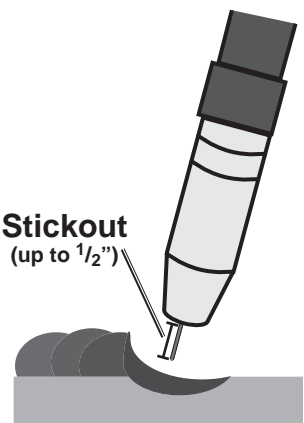
Stickout
(up to 1/2")

Note: If Welder is used too long, the amber Overload Indicator (22) will light and the Welder Gun will shut off until the welder cools. If this happens, rest the Gun on an electrically non-conductive, heat-resistant surface, such as a concrete slab, well clear of the ground clamp. Wait about 8-10 minutes with the Power Switch ON for the welder to cool. When the welder can be used again, use shorter welding periods and longer rest periods to help prevent needless wear.

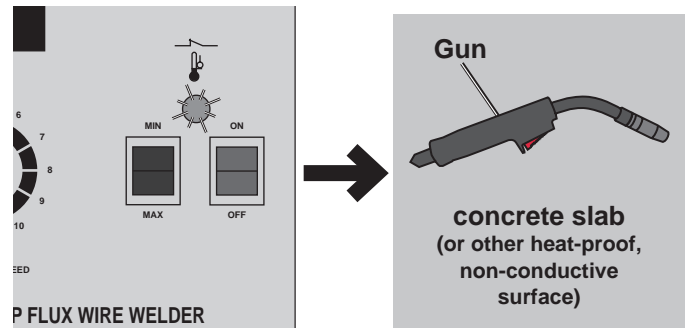

7. **After welding the test weld on a piece of scrap for a few seconds, stop, and check your progress.** Clean, then compare your weld's appearance with the diagrams and descriptions in the **Welding Tips** section starting on the next page. After making any necessary adjustments, continue to weld **while carefully following the DUTY CYCLE guidelines as explained on page 16.**

After practice welding for a few seconds, STOP and examine your weld using the guidelines starting on the next page.

FOLLOW DUTY CYCLE!

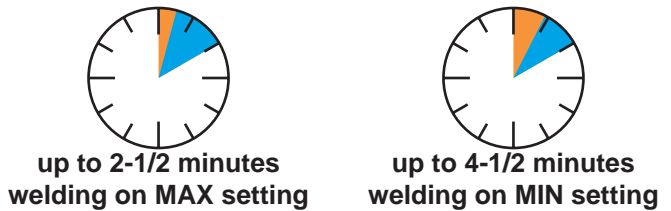

8. **When the weld is complete, lift the Gun and welding wire clearly away from any grounded object, and turn the Power Switch off.**

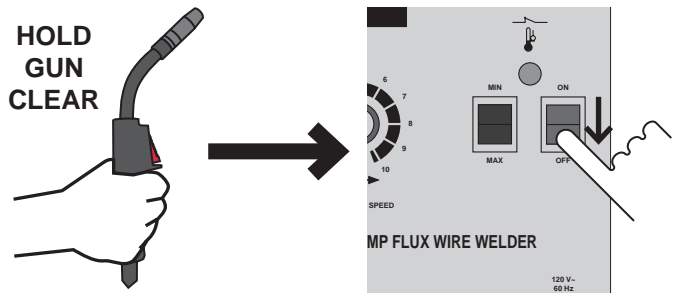

9. **Set the Gun down on a heat-proof, electrically non-conductive surface. Unplug the Power Cord.**

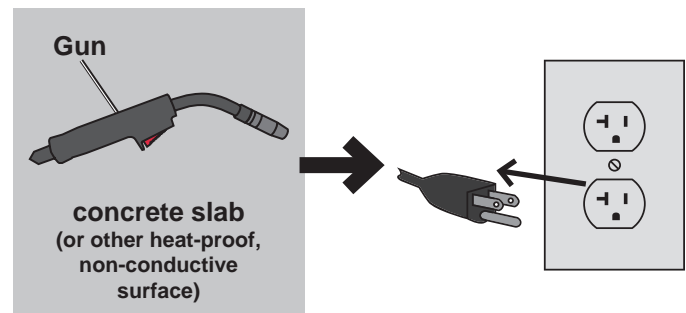

WELDING TIPS

A good way to test welding technique is to examine a weld's appearance after it has cooled and the slag has been removed. Then, better welding can be learned by adjusting your weld technique to remedy any problems found.

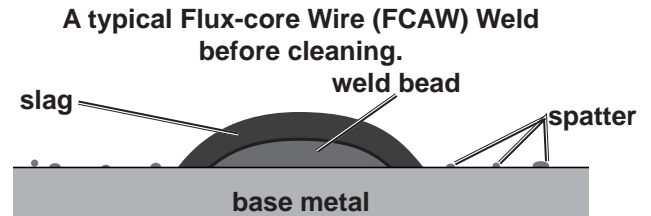

Cleaning the Weld

⚠ WARNING TO PREVENT SERIOUS INJURY:



Continue to wear ANSI-approved safety goggles and protective wear when cleaning a weld. Sparks or chips may fly when cleaning.

1. A weld from flux core wire will be covered by slag, use the Chipping Hammer to knock this off. **Be careful not to damage the weld or base material.**
2. Then, use the Wire Brush to further clean the weld or use an angle grinder (sold separately) to shape the weld.

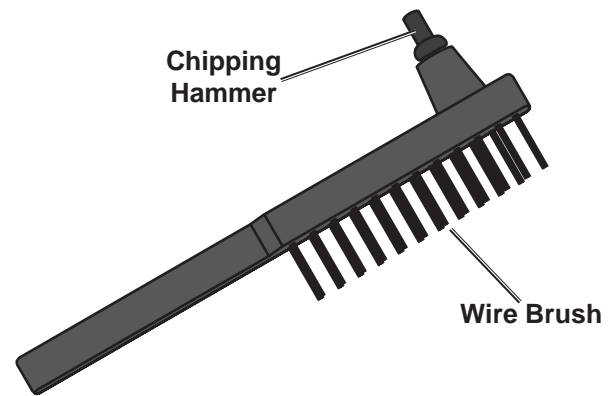

STRIKE TEST

A test weld on a **PIECE OF SCRAP** can be tested by using the following procedure. **WEAR ANSI GOGGLES DURING THIS PROCEDURE.**

WARNING! This test **WILL** damage the weld it is performed on. This test is **ONLY** an indicator of weld technique and is not intended to test working welds.

1. After two scraps have been welded together and the weld has cooled, clamp one scrap in a sturdy vise.
2. Stay clear from underneath while you strike the opposite scrap with a heavy hammer, preferably a dead-blow hammer.
3. A **GOOD WELD** will deform but not break, as shown on top. A **POOR WELD** will be brittle and snap at the weld, as shown on bottom.

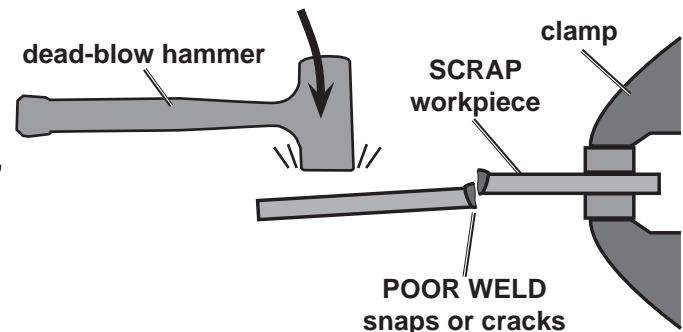
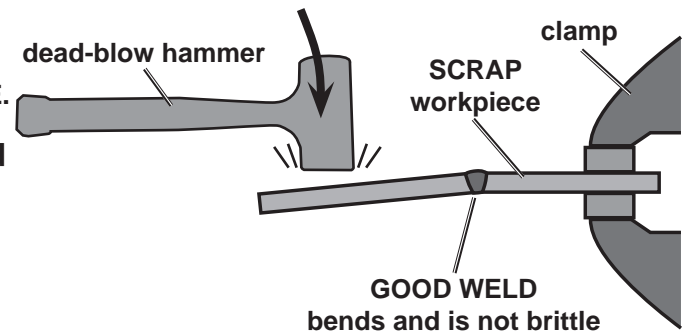

WELD DIAGNOSIS

Workpiece Heat Control / Weld Penetration

INADEQUATE PENETRATION

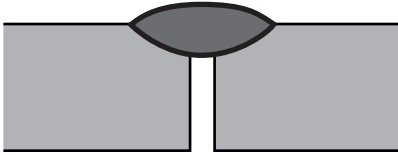

PROPER PENETRATION

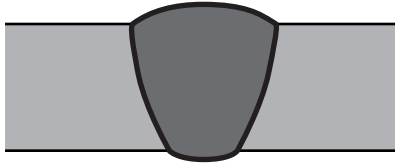

EXCESS PENETRATION OR BURN-THROUGH

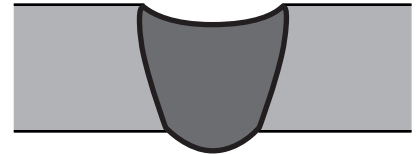

How to increase workpiece heat and increase penetration:
(to weld **THICKER** workpieces properly)

- a. Use MAX setting
- b. Weld more slowly
- c. Use faster wire feed
- d. Use shorter stickout

How to reduce workpiece heat and limit penetration:
(to weld **THINNER** workpieces properly)

- a. Use MIN setting
- b. Weld more quickly
- c. Use slower wire feed
- d. Use longer stickout

Example Weld Diagrams

Good Weld	Current Too Low	Current Too High or Wire Feed Too Fast	Weld Speed Too Fast	Weld Speed Too Slow	Stickout Too Long
	TO CORRECT:	TO CORRECT:	TO CORRECT:	TO CORRECT:	TO CORRECT:

WELD PROBLEMS

Penetration (Workpiece Heat Control)

EXCESS PENETRATION OR BURN-THROUGH

Weld droops on top and underneath, or falls through entirely, making a hole.

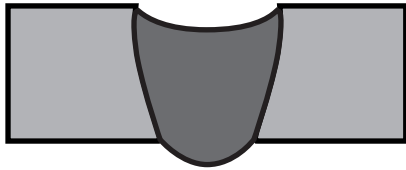

PROPER PENETRATION
Weld is visible underneath and bulges slightly on top.

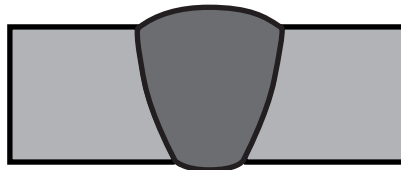

PROFILE VIEWS

INADEQUATE PENETRATION
Weld does not contact the joint fully, just on the surface.

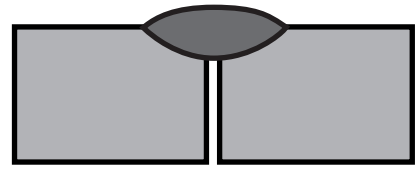

POSSIBLE CAUSES AND SOLUTIONS

1. **Workpiece overheating:**
Reduce wire feed speed.
Use MIN setting.
2. **Welding speed too slow:**
Increase welding speed and ensure that welding speed is kept steady.
3. **Excessive material at weld:**
Reduce wire feed speed.

POSSIBLE CAUSES AND SOLUTIONS

1. **Incorrect welding technique:**
Maintain $\frac{1}{2}$ " or less stickout.
Keep arc on leading edge of weld puddle.
Hold gun at proper angles.
2. **Insufficient weld heat:**
Reduce welding speed.
Use MAX setting.
3. **Workpieces too thick/close:**
Bevel thick workpieces, allow slight gap, and weld in several passes.
4. **Insufficient weld material:**
Increase wire feed speed.

Weld Not Adhering Properly

Gaps present between weld and previous bead or between weld and workpiece. See areas below.

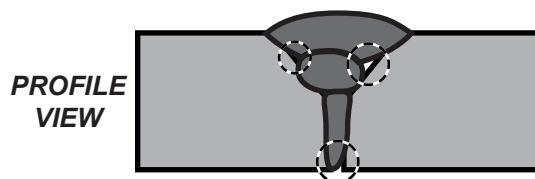

PROFILE VIEW

POSSIBLE CAUSES AND SOLUTIONS

1. **Incorrect welding technique:**
Place stringer bead at correct place in joint.
Adjust workpiece position or weld angle to permit proper welding to bottom of piece.
Pause briefly at sides during weave bead.
Keep arc on leading edge of weld puddle.
Hold gun at proper angles.
2. **Insufficient weld heat:**
Increase current and/or wire feed speed.
3. **Dirty workpiece:**
Clean workpiece down to bare metal.
4. **Insufficient weld material:**
Increase wire feed speed.

Bend at Joint

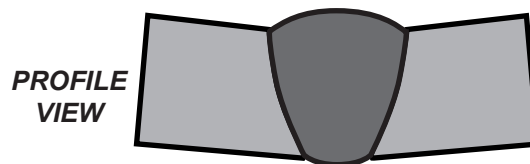

PROFILE VIEW

POSSIBLE CAUSES AND SOLUTIONS

1. **Improper clamping:**
Clamp workpieces securely.
Make tack welds to hold workpieces.
- Excessive heat:**
Weld a small portion and allow to cool before proceeding.
Increase weld speed.
Reduce wire feed speed.

Coat of Slag Over Weld

TOP
VIEW



PARTIALLY CHIPPED AWAY TO SHOW WELD

Slag is a necessary part of a flux-core wire weld. It shields the weld from impurities. Clean off the slag with the Chipping Hammer and Wire Brush after welding.

Porosity

Small cavities or holes in the bead.

TOP
VIEW

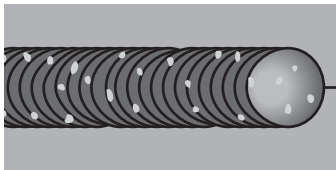

POSSIBLE CAUSES AND SOLUTIONS

1. **Dirty workpiece or welding wire:**
Clean workpiece down to bare metal. Make certain that wire is clean and free from oil, coatings, and other residues.
2. **Inconsistent welding speed:**
Maintain steady weld speed.
3. **Stickout too long:**
Reduce stickout.

Crooked/Wavy Bead

TOP
VIEW

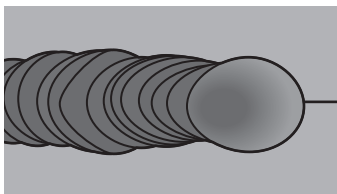

POSSIBLE CAUSES AND SOLUTIONS

1. **Inaccurate welding:**
Use two hands or rest hand on steady surface.
2. **Inconsistent welding speed:**
Maintain steady weld speed.
3. **Stickout too long:**
Reduce stickout.

Excessive Spatter

Fine spatter is normal.

Spatter that is grainy and large is a problem.

TOP
VIEW

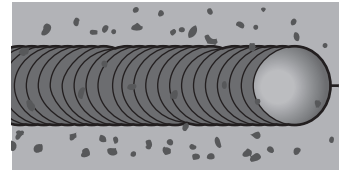

POSSIBLE CAUSES AND SOLUTIONS

1. **Dirty workpiece or welding wire:**
Clean workpiece down to bare metal. Make certain that wire is clean and free from oil, coatings, and other residues.
2. **Wire feeding too fast:**
Reduce wire feed speed.
3. **Stickout too long:**
Reduce stickout.

Burn-Through

Base material melts away, leaving a hole in the weld.

TOP
VIEW

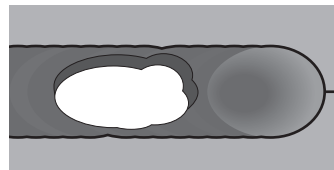

POSSIBLE CAUSES AND SOLUTIONS

1. **Workpiece overheating:**
Reduce current and/or wire feed speed.
2. **Welding speed too slow:**
Increase welding speed and ensure that welding speed is kept steady.
3. **Excessive material at weld:**
Reduce wire feed speed.

SERVICE

⚠️ WARNING TO PREVENT SERIOUS INJURY, FIRE AND



BURNS:

Unplug the welder, rest the Gun on a heat-proof, electrically non-conductive surface, and allow all parts of the Welder to cool thoroughly before service.

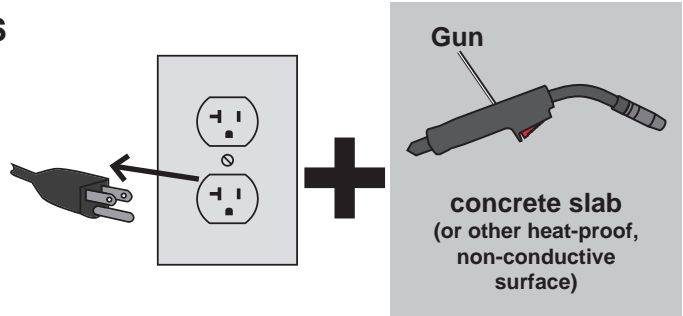

1. Periodically remove the Right and Left side panels (12 and 13), and using compressed air, blow out all dust from the interior.
2. Store in a clean and dry location.
3. **For optimal weld quality, clean and inspect the Contact Tip (2b) and Nozzle (3) before each use, as follows:**

Nozzle (3) Inspection, Cleaning, and Replacement

1. **Make sure that the entire Gun is completely cool and that the Power Cord is unplugged from the electrical outlet before proceeding.**
2. Turn the Nozzle counterclockwise while pulling to remove.
3. Scrub the interior of the Nozzle clean with a wire brush.
4. Examine the end of the Nozzle. The end should be flat and even. If the end is uneven, chipped, melted, cracked, or otherwise damaged, the Nozzle will adversely effect the weld and should be replaced.
5. Reinstall the Nozzle after inspecting and cleaning the Contact Tip.

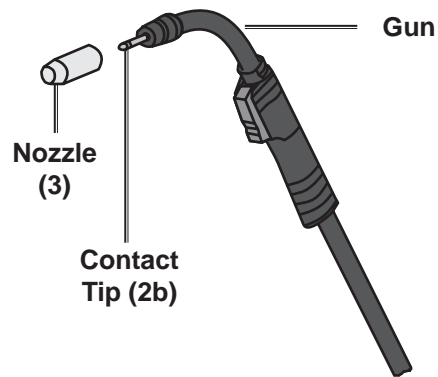

Contact Tip (2b) Inspection, Cleaning, and Replacement

1. **Make sure that the entire Gun is completely cool and that the Power Cord is unplugged from the electrical outlet before proceeding.**
2. Remove the Nozzle as explained in the previous subheading. Using the third oval hole on the Multi-wrench (43), turn the Contact Tip counterclockwise and slide it off the welding wire.
3. Scrub the exterior of the Tip clean with a wire brush. Clean out the inside of the tip with a tip cleaner (sold separately). Check that the Tip is the proper type for the wire size used (.035" tip for .030–.035" wire).
4. Examine the shape of the hole at the end of the Contact Tip. It should be an even circle, it should not be oblong or have any bulges in it.
5. If any problems are noted, Contact Tip replacement would be advisable. Make sure to select a new Tip that is the correct size for the welding wire used (.035" tip for .030–.035" wire).
6. Reinstall the Tip and securely reinstall the Nozzle as well.

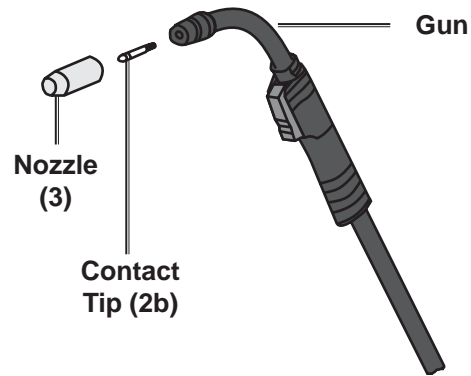

TROUBLESHOOTING

IMPORTANT!

Be **CERTAIN** to shut off the Welder, disconnect it from power, and discharge the Gun to ground before adjusting, cleaning, or repairing the unit.

Wire feed motor runs but wire does not feed properly

POSSIBLE CAUSES AND SOLUTIONS

1. **Insufficient wire feed tension:**
Increase wire feed tension properly - follow step 16 on page 13.
2. **Incorrect wire feed roll size:**
Replace with the proper wire feed roll - follow the *Wire Spool Installation* instructions, starting on page 10.
Flip over wire feed roll if necessary.
3. **Damaged Gun, cable, or liner assembly:**
Have a qualified technician inspect these parts and replace as necessary.

Wire creates a bird's nest during operation

POSSIBLE CAUSES AND SOLUTIONS

1. **Excess wire feed tension:**
Adjust wire feed tension properly - follow step 16 on page 13.
2. **Incorrect contact tip size:**
Replace with the proper tip for the wire.
3. **Gun end not inserted into drive housing properly:**
Loosen gun securing bolt and push gun end into housing just enough so that it does not touch wire feed mechanism.
4. **Damaged liner:**
Have a qualified technician inspect and repair/replace as necessary.

TROUBLESHOOTING (continued)

IMPORTANT!

Be **CERTAIN** to shut off the Welder, disconnect it from power, and discharge the Gun to ground before adjusting, cleaning, or repairing the unit.

Power switch (7a) lights, but welder does not function when switched on

POSSIBLE CAUSES AND SOLUTIONS

1. **Tripped thermal protection device:**
Shut the welder's switch to off and allow it to cool for at least 20 minutes. Reduce duration or frequency of welding periods to help reduce wear on the welder. Refer to **Duty Cycle** section on page 16.
2. **Faulty or improperly connected Trigger (1c):**
Qualified technician must check and secure/replace Trigger (1c).
3. **Internal fuse blown:**
Check/replace according to the following directions.
 - a. **WARNING! Turn the welder OFF and unplug it before proceeding.**
 - b. Press on the Cover Latch (8), then lift the Cover (31) using Handle (30). Remove Left Side Panel (13).
 - c. Examine fuse on panel to see if metal wire inside is broken or not. See illustration.

NOTE: The circuit board is *very delicate* and will be damaged if it is not supported while the fuse is manipulated. If you have any doubts about doing this without damaging the welder, have a qualified technician replace the fuse.

- d. If the fuse is broken, carefully support the circuit board with a gloved hand while you remove the old fuse. Support the circuit board from behind while you install a new 2 Amp, 250 Volt fuse of the same type. **NEVER use another type or size fuse.**
- e. Reinstall the Left Side Panel (13), close the Cover (31), and test the unit for proper function before use.

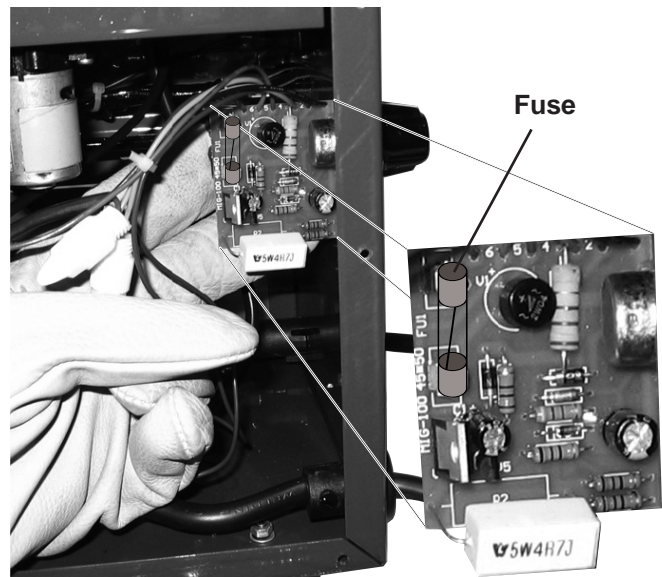

TROUBLESHOOTING (continued)

IMPORTANT!

Be **CERTAIN** to shut off the Welder, disconnect it from power, and discharge the Gun to ground before adjusting, cleaning, or repairing the unit.

Power switch (7a) does not light when switched on

POSSIBLE CAUSES AND SOLUTIONS

Unit is not connected to outlet properly or outlet is unpowered:

Verify the voltage at the outlet and the connection to the outlet.

If voltage is not present at outlet, check circuit breaker/GFCI devices; if any are tripped, determine and remedy cause before resetting. Verify that the circuit is designed to supply the required input amperage as detailed on the **Specifications** table.

Wire Feeds, but arc does not ignite

POSSIBLE CAUSES AND SOLUTIONS

1. **Improper ground connection:**

Make certain that the workpiece is contacted properly by the Ground Clamp and that the workpiece is properly cleaned near the ground clamp and the welding location.

2. **Improperly sized or excessively worn Contact Tip (2b):**

Verify that Contact Tip (2b) is the proper size for the wire. Check that the hole in the tip is not deformed or enlarged. Also, check that the tip is not dirty; this would prevent a good connection. If needed, replace Contact Tip (2b) with proper size and type.

TROUBLESHOOTING (continued)

IMPORTANT!

Be **CERTAIN** to shut off the Welder, disconnect it from power, and discharge the Gun to ground before adjusting, cleaning, or repairing the unit.

Weak Arc strength

POSSIBLE CAUSES AND SOLUTIONS

1. **Incorrect line voltage:**
Check the line voltage and, if insufficient, have a licensed electrician remedy the situation.
2. **Improper gauge or length of extension cord:**
Extension cords are not recommended. If possible, eliminate the use of an extension cord. If an extension cord is needed, refer to the guidelines on page 7.

Welding arc not stable

POSSIBLE CAUSES AND SOLUTIONS

1. **Wire not feeding properly:**
See first *Troubleshooting* section - **Wire feed motor runs but wire does not feed properly.**
2. **Incorrect contact tip size:**
Replace with the proper tip for .030" wire.
3. **Incorrect wire feed speed:**
Adjust wire feed speed to achieve a more stable arc.
4. **Loose Gun cable or ground cable:**
Check to ensure that all connections are tight.
5. **Damaged Gun or loose connection within Gun:**
Have a qualified technician inspect and repair/replace as necessary.
6. **Adjust current setting:**
Make sure setting matches recommended setting on chart.

PARTS LISTS AND DIAGRAMS

Wiring Schematic

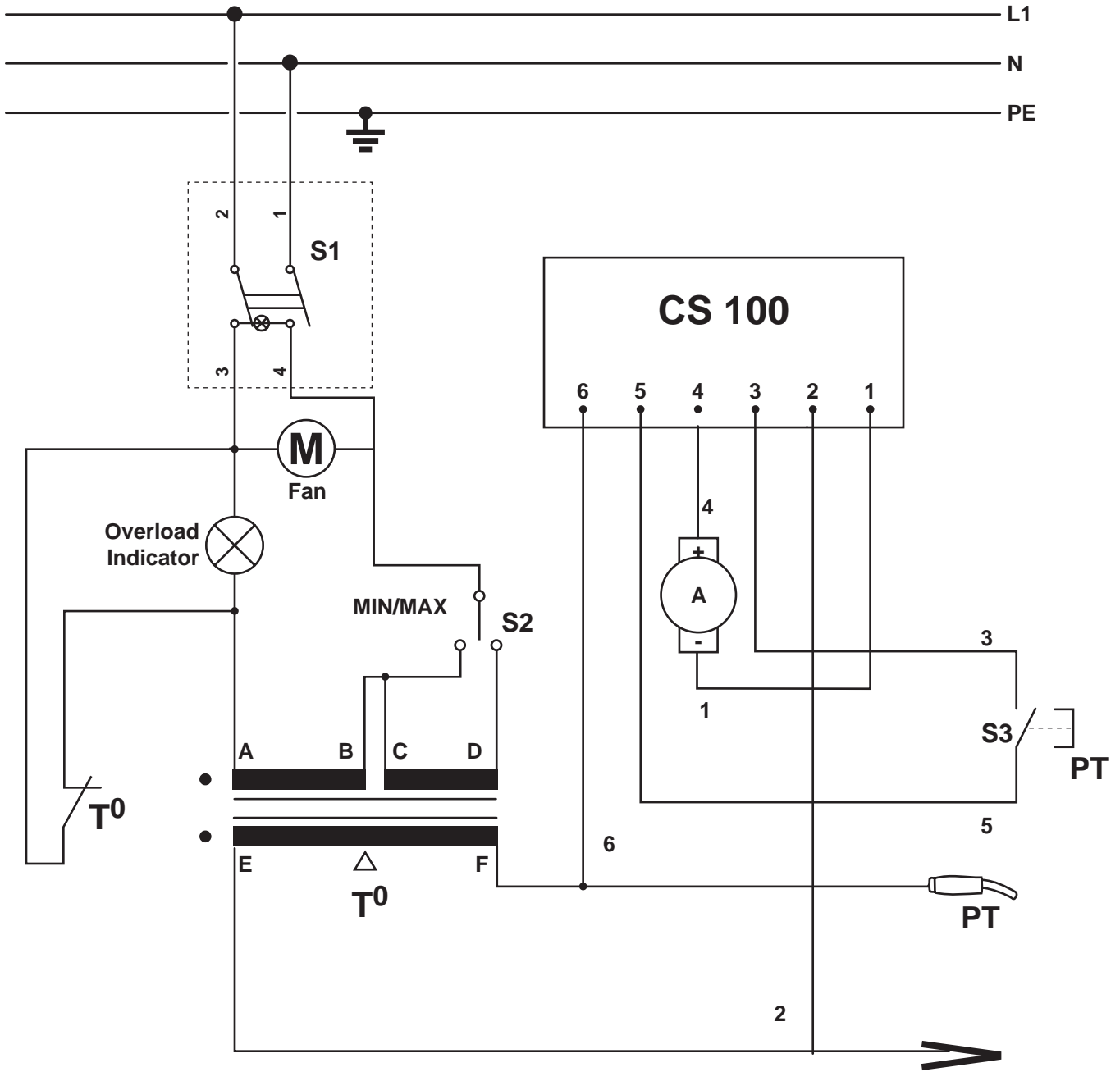

SAFETY

SETUP

BASIC WELDING

WELDING TIPS

SERVICE

Parts List

Part	Description	Q'ty
1a	Back Handle	1
1b	Front Handle	1
1c	Trigger	1
1d	Handle Lock Ring	1
1e	Gun Tube	1
2b	.9 mm Contact Tip	1
3	Nozzle	1
4	Wire Liner	1
5	Gun Cable Clamp A	1
6	Gun Cable Clamp B	1
7a	Power Switch	1
7b	Current Switch (MIN/MAX)	1
8	Cover Latch	1
9	Wire Speed Dial	1
10	Nut	1
11	Feed Control Circuit Board	1
12	Right Side Panel	1
13	Left Side Panel	1
14	Base Frame	1
15	Foot	4
16	Washer	4
17	Screw, ST4.2*13	4
18	Transformer Bracket	2
19	Thermostat	1
20	Transformer	1
21	Middle Partition	1
22	Overload Indicator	1
23	Wire Feed Assembly	1

Part	Description	Q'ty
24	Spool Spring	1
25	Wing Nut, M6	1
26	Spool Retaining Nut	1
27	Wire Spool	1
28	Spool Spindle	1
29	Screw, ST4.2*25	1
30	Handle	1
31	Cover	1
32	Power Cord	1
33	Ground Cable	1
34	Feed Roller	1
35	Feed Bearing	1
36	Feed Swing Arm	1
37	Feed Tensioner	1
38	Face Shield (shade #10)	1
39	Wire Brush / Chipping Hammer	1
40	Washer	1
41	Nut	1
42	Bolt	1
43	Multi-wrench (for Contact Tip)	1
44	Feed Roller Bracket	1
45	Roller Bracket Screw	2
46	Roller Bracket Washer	2
47	Washer	1
48	Support Bracket	1
49	Fan	1
50	Lock Washer	1

PLEASE READ THE FOLLOWING CAREFULLY

THE MANUFACTURER AND/OR DISTRIBUTOR HAS PROVIDED THE PARTS DIAGRAM IN THIS MANUAL AS A REFERENCE TOOL ONLY. NEITHER THE MANUFACTURER NOR DISTRIBUTOR MAKES ANY REPRESENTATION OR WARRANTY OF ANY KIND TO THE BUYER THAT HE OR SHE IS QUALIFIED TO MAKE ANY REPAIRS TO THE PRODUCT OR THAT HE OR SHE IS QUALIFIED TO REPLACE ANY PARTS OF THE PRODUCT. IN FACT, THE MANUFACTURER AND/OR DISTRIBUTOR EXPRESSLY STATES THAT ALL REPAIRS AND PARTS REPLACEMENTS SHOULD BE UNDERTAKEN BY CERTIFIED AND LICENSED TECHNICIANS AND NOT BY THE BUYER. THE BUYER ASSUMES ALL RISK AND LIABILITY ARISING OUT OF HIS OR HER REPAIRS TO THE ORIGINAL PRODUCT OR REPLACEMENT PARTS THERETO, OR ARISING OUT OF HIS OR HER INSTALLATION OF REPLACEMENT PARTS THERETO.

Assembly Diagram

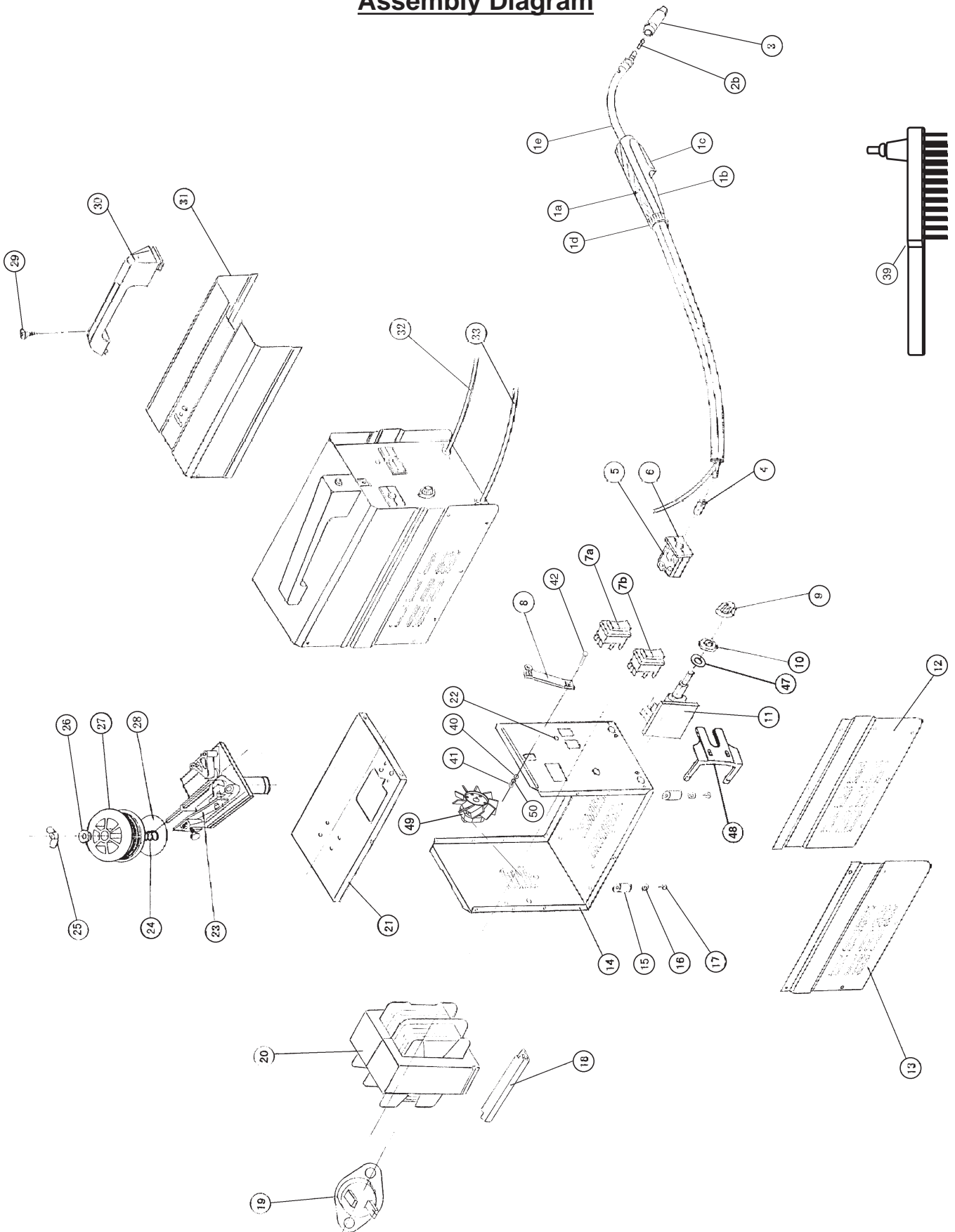

Detail of Part 23

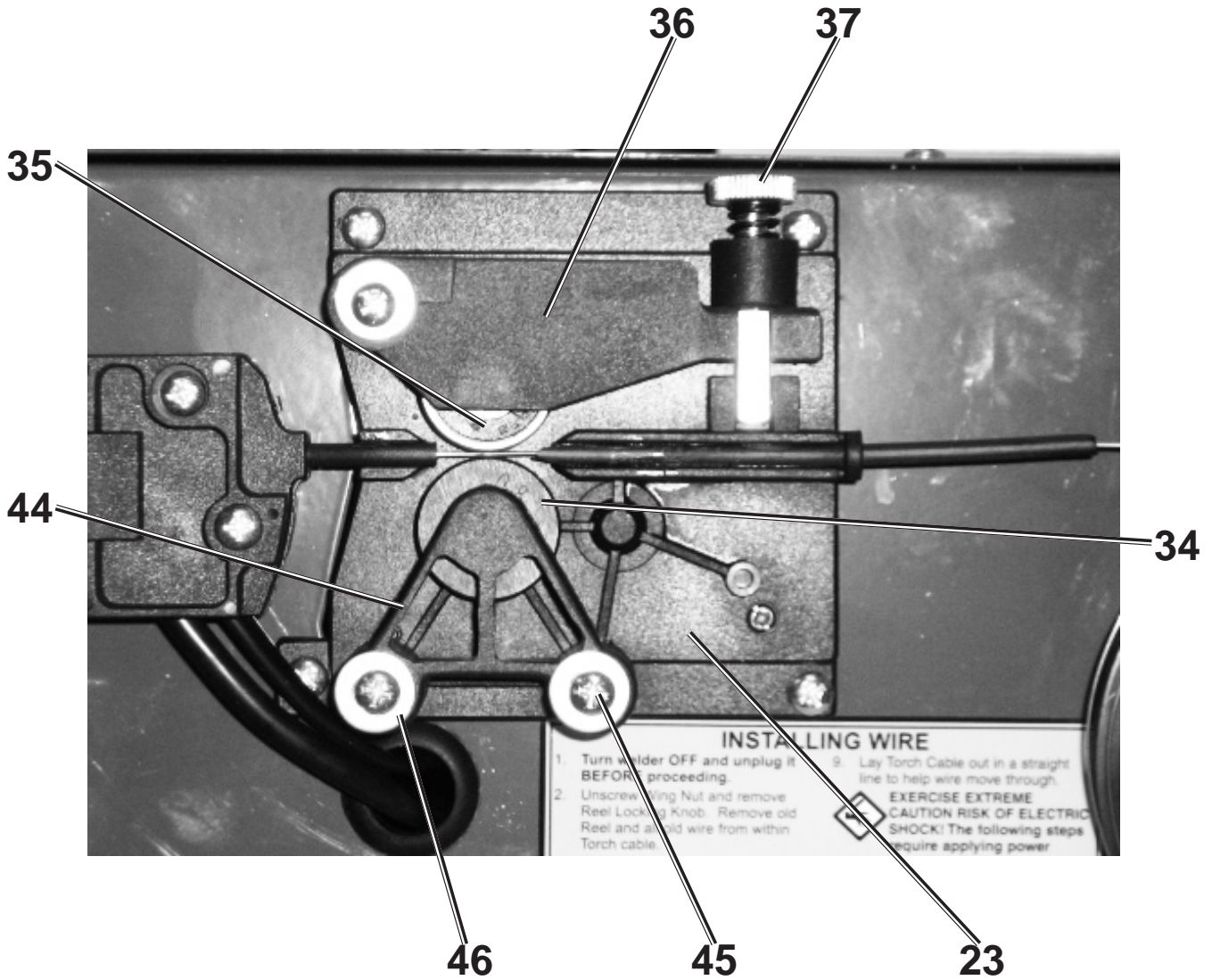

Record Product's Serial Number Here: _____

Note: If product has no serial number, record month and year of purchase instead.

Note: Some parts are listed and shown for illustration purposes only, and are not available individually as replacement parts.

LIMITED 1 YEAR / 90 DAY WARRANTY

Harbor Freight Tools Co. makes every effort to assure that its products meet high quality and durability standards, and warrants to the original purchaser that for a period of ninety days from date of purchase that the Gun, liner, wire feed mechanism (if applicable), welding clamps, electrode holders, cables and accessories packed with the welder are free of defects in materials and workmanship. **This Limited 90 Day/1 Year Warranty shall not apply to consumable parts such as tips, welding wire, and gas nozzles.** Harbor Freight Tools also warrants to the original purchaser, for a period of one year from date of purchase, that the transformer and rectifier are free from defects in materials and workmanship (90 days if used by a professional contractor or if used as rental equipment). This warranty does not apply to damage due directly or indirectly to misuse, abuse, negligence or accidents, repairs or alterations outside our facilities, normal wear and tear, or to lack of maintenance. We shall in no event be liable for death, injuries to persons or property, or for incidental, contingent, special or consequential damages arising from the use of our product. Some states do not allow the exclusion or limitation of incidental or consequential damages, so the above limitation of exclusion may not apply to you. **THIS WARRANTY IS EXPRESSLY IN LIEU OF ALL OTHER WARRANTIES, EXPRESS OR IMPLIED, INCLUDING THE WARRANTIES OF MERCHANTABILITY AND FITNESS.**

To take advantage of this warranty, the product or part must be returned to us with transportation charges prepaid. Proof of purchase date and an explanation of the complaint must accompany the merchandise. If our inspection verifies the defect, we will either repair or replace the product at our election or we may elect to refund the purchase price if we cannot readily and quickly provide you with a replacement. We will return repaired products at our expense, but if we determine there is no defect, or that the defect resulted from causes not within the scope of our warranty, then you must bear the cost of returning the product.

This warranty gives you specific legal rights and you may also have other rights which vary from state to state.

**3491 Mission Oaks Blvd. • PO Box 6009
Camarillo, CA 93011 • (800) 444-3353**